



Technical Data

ClassicSeries™ PARTITIONS AND SCREENS WITH LAMINATED PLASTIC SURFACES AND EDGES

1540 SERIES

Specify Product Application:

- Toilet Partitions
- With Outswing Door
- Urinal Screens
- Stiles with Welded Core (.63)
- With Stainless Steel Hardware (.64)

Specify Series Required:

- 1541 Series Floor-Anchored
- 1542 Series Overhead-Braced
- 1545 Series Wall-Hung Urinal Screens
- 1548 Series Ceiling-Hung for 8' (244cm) Ceiling or as required up to 9' (274cm) Ceiling.

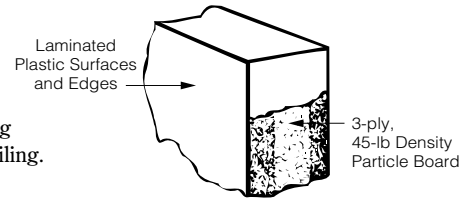

STANDARD-SIZE COMPONENTS:

Stiles: For compartments – 3", 4", 5", 6", 8"^a, 10", 12", 16", 20", or 24" (8, 10, 13, 15, 20, 25, 30, 41, 51, or 61cm) wide; for screens – 6" (15cm) wide. *Floor-anchored* – 69" (175cm) high; *overhead-braced* – 82-5/16" (209cm) high; *ceiling-hung* – 83" (211cm) high for 8' 0" (244cm) ceilings or as required up to 9' (274cm) ceilings.

Doors: 58" (147cm) high. *Inswing doors* are standard for 22" to 37" (56–94cm) widths in whole-inch increments. *Outswing^b doors* are standard for 25" to 37" (64–94cm) widths in whole-inch increments.

Wall Posts: 1-1/2" wide, 58" high (4 x 147cm).

Panels: For Compartments – Up to 84" (213cm) wide; 58" (147cm) high. For wall-hung screens – 42" or 48" (107 or 122cm) high; 18" or 24" wide (46 or 61cm). For ceiling-hung and floor-anchored screens – 58" (147cm) high; 24", 36", 48", or 60" (61, 91, 122, or 152cm) wide.

^a Minimum 8" (20cm) wide stile recommended for ceiling-hung and floor-anchored compartments.

^b Use outswing doors to comply with local codes requiring access for physically disabled persons.

COMPARTMENT AND SCREEN ELEVATIONS

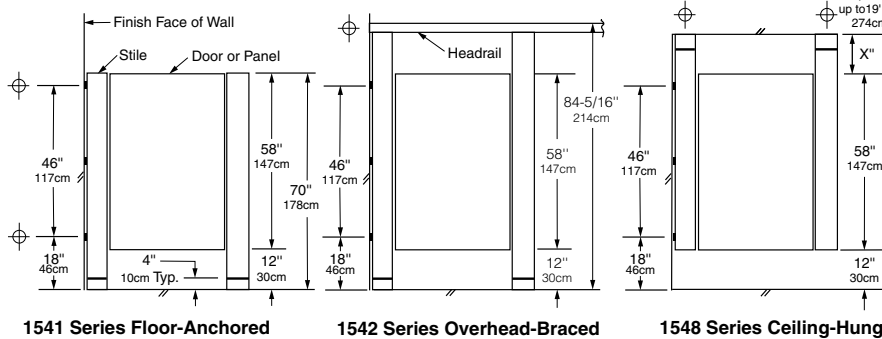

1541 Series Floor-Anchored

1542 Series Overhead-Braced

1548 Series Ceiling-Hung

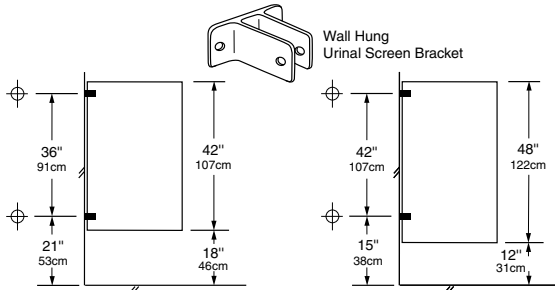

1545 Series Wall-Hung 42" or 48"

⊕ These mounting points require wall backing. For suggested backing methods, Bobrick Advisory Bulletins TB-32 for ceiling-hung installations and TB-46 for floor-anchored are available upon request.

TYPICAL HARDWARE DETAILS

Through-Bolted, Bright-Polished, Chrome-Plated Zamak (standard on all compartments)

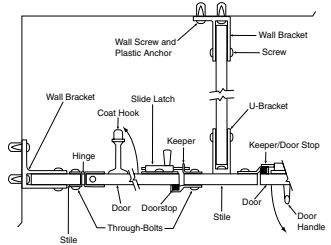

Through-Bolted, Stainless Steel Door Hardware and Concealed Mounting Brackets (.64 option)

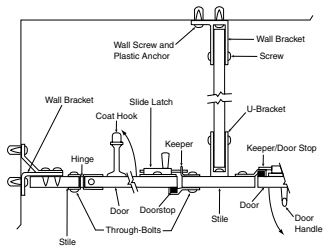

Standard gaps are provided at all walls and between components to allow for hardware attachment. Wall gaps are standard 1/2" to 1"

TYPICAL INSTALLATION DETAILS

Floor-Anchored or Ceiling-Hung Leveling Device (Ceiling Leveling Device Shown)

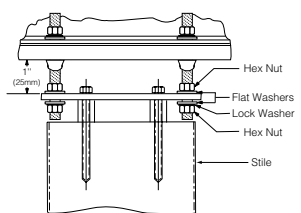

Overhead-Braced Floor Leveling Device

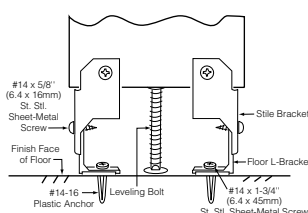

Welded Steel Core Available Floor-Anchored, Overhead-Braced, Ceiling-Hung (.63 option)

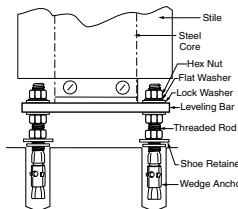

Overhead-Bracing

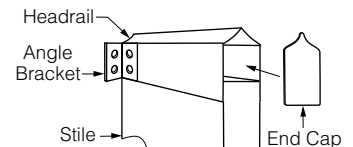

MATERIALS:

Stiles — 1" (25mm) finished thickness: 3-ply, 45-lb (20.4-kg) density, resin-impregnated particle board; surfaces and edges are .050" (1.3mm) thick, high-pressure plastic laminate with colored face sheets and matte finish.

Leveling Device — Overhead-Braced Series: 12-gauge (2.8mm), 3" x 1-1/4" (75 x 32mm) plated steel stile bracket factory installed to bottom of stile. Furnished with leveling bolt, shoe retainer, floor L-bracket, plastic anchor #14-16, #14 x 5/8" (M6.3 x 16mm) stainless steel sheet-metal screws and #14 x 1-3/4" (M6.3 x 45mm) stainless steel sheet-metal floor screws.

Leveling Device — Floor-Anchored or Ceiling-Hung: 3/8" x 1" (10 x 25mm) steel bar, zinc-chromate plated, bolted to stile using 6" x 3/8" (152 x 10mm) diameter carbon steel lag bolt. Furnished with 3/8" (10mm) diameter threaded rods, hex nuts, washers, spacer sleeve (ceiling-hung only), expansion shield and shoe retainer.

Stiles with Welded Core (.63 option) — 1" (25mm) finished thickness: 3-ply, 45-lb (20.4-kg) density, resin-impregnated particle board is bonded to each side of 11-gauge (3.2mm) sheet steel that serves as reinforcing core; surfaces and edges are .050" (1.3mm) thick, high-pressure plastic laminate with colored face sheets and matte finish. **Leveling Device:** 3/8" x 7/8" (10 x 22mm) steel bar is welded to sheet-steel core of stile, forming a single structural unit; furnished with 3/8" (10mm) diameter threaded rods, hex nuts, lock washers, flat washers, expansion shields, and shoe retainers. **Shoe:** 18-8 S, type-304, 22-gauge (0.8mm) stainless steel with satin finish; 4" (102mm) high. Patented one-piece shoe is open-ended, and may be mounted blind against wall using shoe clip fastener on wall side.

Panels and Doors — 1" (25mm) finished thickness: 3-ply, 45-lb (20.4-kg) density, resin-impregnated particle board; surfaces and edges are .050" (1.3mm) thick, high-pressure plastic laminate with colored face sheets and matte finish. **Headrail:** (1542 Series Only): Extruded anodized aluminum with satin finish. Enclosed construction with vandal-resistant sloping top. **Wallpost:** 1-1/2" (38mm) x 1" (25mm) x 58" (147cm), 16 gauge (1.6mm) thick, 18-8 S, type-304 stainless steel. Pre-drilled for door mounting hardware.

Door and Mounting Hardware — Hinges, door latches, door keepers, coat hooks, and mounting brackets are constructed of chrome-plated zamak. Toilet compartment door is locked from inside by sliding door latch into keeper. A locked compartment may be opened from outside by lifting door to disengage latch from keeper. Doorstop prevents inswing door from swinging out beyond stile; on outswing door, the doorstop/keeper prevents it from swinging in beyond stile. Combination coat hook and bumper reduces damage from door inside compartment.

Door and Mounting Hardware (.64 option) — Hinges, slide latches, door keepers, and coat hooks are constructed of cast, type-304 stainless steel with satin finish. Theft-resistant, stainless steel one-way screws are furnished for all inswing and outswing doors. Mounting brackets are constructed of 18-8 S, type-304, heavy-gauge stainless steel with satin finish. Stainless steel pin-head torx screws are furnished for mounting brackets. Toilet compartment door is locked from inside by sliding door latch into keeper. A locked compartment may be opened from outside by lifting door to disengage latch from keeper.

INSTALLATION:

Bobrick installation instructions are packed with each shipment and are available also in advance on request.

Notes:

1. Where water from showers or hose-down cleaning comes in contact with partitions, Bobrick 1080 Series water-resistant, solid phenolic partitions are recommended.
2. Ceiling-hung partitions require structural members (not furnished by Bobrick) in ceiling. For suggested types of ceiling support systems, see Bobrick Advisory Bulletin TB-32.
3. Wall backing is required to secure the mounting brackets of panels, stiles, and wall posts. For suggested wall backing, see Bobrick Advisory Bulletin TB-46.
4. Floor-anchored stiles are furnished with expansion anchors and threaded rods. The expansion anchors require minimum 2" (50mm) penetration into minimum 3" (75mm) thick structural concrete.
5. Bobrick stainless steel partition-mounted washroom accessories are available for mounting in panels between two compartments. See current Bobrick Catalog for description of accessories. Cutouts in panels can be pre-cut for Bobrick models at factory if location and size of all cutouts and Bobrick model numbers are furnished at time of order.

GUARANTEE:

Bobrick Toilet Partitions are guaranteed to be free from defects in material and workmanship for a period of one year from date of purchase. Any products returned to Bobrick under this guarantee will be repaired or replaced at no charge.

SPECIFICATION:

Laminated plastic _____ (insert one: toilet partitions or urinal screens) shall be _____ (insert one: floor-anchored, ceiling-hung, overhead-braced or wall-hung). Stiles, panels, and doors shall have a finished thickness of 1" (25mm). Core of panels, doors, and stiles* shall be 3-ply, 45-lb (20.4-kg) density, resin-impregnated particle board. Stiles shall have a one-piece, type-304, satin-finish stainless steel shoe that is 4" (102mm) high. Surfaces and edges shall be .050" (1.3mm) thick, high-pressure plastic laminate with colored face sheets and matte finish; bonding shall be done using adhesives especially formulated to prevent delamination from moisture and heat normally existing in public washrooms. Stiles, panels, and doors shall be _____ (insert color name and number from current Bobrick Catalog). Headrails for overhead-braced compartments shall be anodized aluminum with satin finish. All door hardware and mounting brackets shall be chrome-plated zamak**. Theft-resistant, one-way screws shall be furnished for all door hardware. Plated-steel Phillips screws shall be furnished for all mounting brackets. A coat hook shall be furnished for each door.

*To specify Stiles with Welded Cores, replace stile construction specification with: .63 option Stiles shall have a finished thickness of 1" (25mm). Stiles shall have 3-ply, 45-lb (20.4kg) density, resin-impregnated particle board bonded to each side of 11-gauge (3.2mm) sheet steel that serves as reinforcing core. Stiles shall have leveling device that is welded to the sheet-steel core and concealed by a one-piece, type-304, satin-finish stainless steel shoe that is 4" (102mm) high.

**To specify Stainless Steel Hardware, replace hardware specification with: .64 option Hinges, slide latches, door keepers and coat hooks shall be cast, type-304 stainless steel with satin finish. Theft-resistant, stainless steel one-way screws are furnished for all inswing and outswing doors. Mounting brackets shall be 18-8 S, type-304, heavy-gauge stainless steel with satin finish. Stainless steel pin-head torx screws shall be furnished for all mounting brackets. Toilet compartment door shall be locked from inside by sliding door latch into keeper. A locked compartment may be opened from outside by lifting door to disengage latch from keeper. Manufacturer's service and parts manual shall be provided to the building owner/manager upon request.

_____ (insert one: Toilet Partitions, Dressing Compartments, Urinal Screens) shall be _____ Series (insert series number) of Bobrick Washroom Equipment, Inc., Clifton Park, New York; Jackson, Tennessee; Los Angeles, California; Bobrick Washroom Equipment Company, Scarborough, Ontario; Bobrick Washroom Equipment Pty. Ltd., Australia; and Bobrick Washroom Equipment Limited, United Kingdom.