



Technical Data

DuraLineSeries™ CLASS A FIRE-RESISTANT SOLID PHENOLIC PARTITIONS AND SCREENS

1180 SERIES

Specify Product Application:

- Toilet Partitions
- Dressing Compartments
- Urinal Screens
- Entrance Screens
- With Outswing Door
- With Institutional Hardware (.67)

Specify Series Required:

- 1181 Series Floor-Anchored
- 1182 Series Overhead-Braced
- 1183 Series Post-to-Ceiling (Screens only)
- 1185 Series Wall-Hung (Screens only)
- 1186 Series Floor-to-Ceiling Anchored
- 1188 Series Ceiling-Hung for 8' 0" (244cm) Ceilings or as required up to 10' 0" (305cm) Ceilings

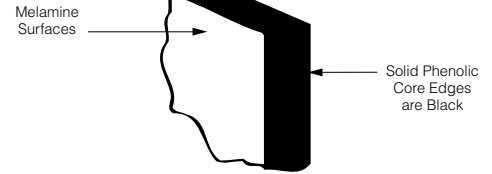

STANDARD-SIZE COMPONENTS:

Stiles: For compartments — 3", 4", 5", 6", 8"^a, 10", 12", 16", 20", or 24" (8, 10, 13, 15, 20, 25, 30, 41, 51, or 61cm) wide; for screens — 6" (15cm) wide. *Floor-anchored* — 69" (175cm) high; *overhead-braced* — 83" (211cm) high; *floor-to-ceiling anchored* — height as required; *ceiling-hung* — 83" (211cm) high for 8' 0" (244cm) ceilings or as required up to 10' 0" (305cm) ceilings.

Doors: 58" (147cm) high. *Inswing doors* are standard for 22" to 37" (56–94cm) widths in whole-inch increments. *Outswing^b doors* are standard for 25" to 37" (64–94cm) widths in whole-inch increments.

Wall Posts: — 1-1/2" wide x 58" high (4 x 147cm).

Panels: For compartments — Up to 84" (213cm) wide; 58" (147cm) high. For wall-hung screens — 18" or 24" (46 or 61cm) wide; 42" or 48" (107 or 122cm) high.

For ceiling-hung and post-to-ceiling screens — 24", 36", 48", or 60" (61, 91, 122, or 152cm) wide; 58" (147cm) high.

Posts: For 1183 Series post-to-ceiling screens only. 1-1/4" (3cm) square. 10 ft (305cm); cut to required height in field.

^a Minimum 8" (20cm) wide stile recommended for ceiling-hung and floor-anchored compartments.

^b Use outswing doors to comply with local codes requiring access for physically disabled persons.

COMPARTMENT AND SCREEN ELEVATIONS

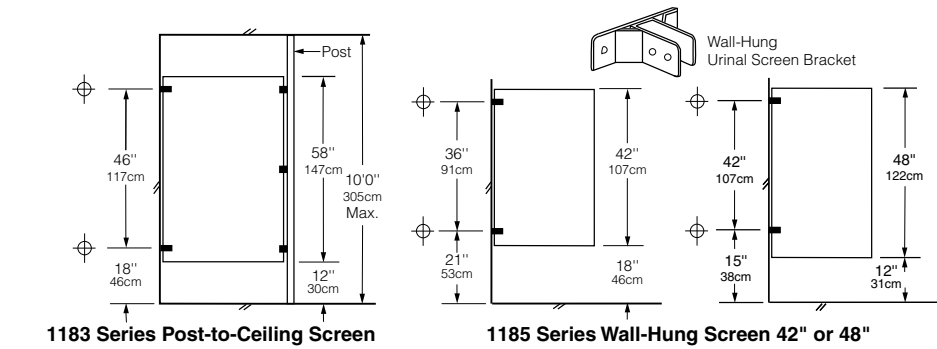
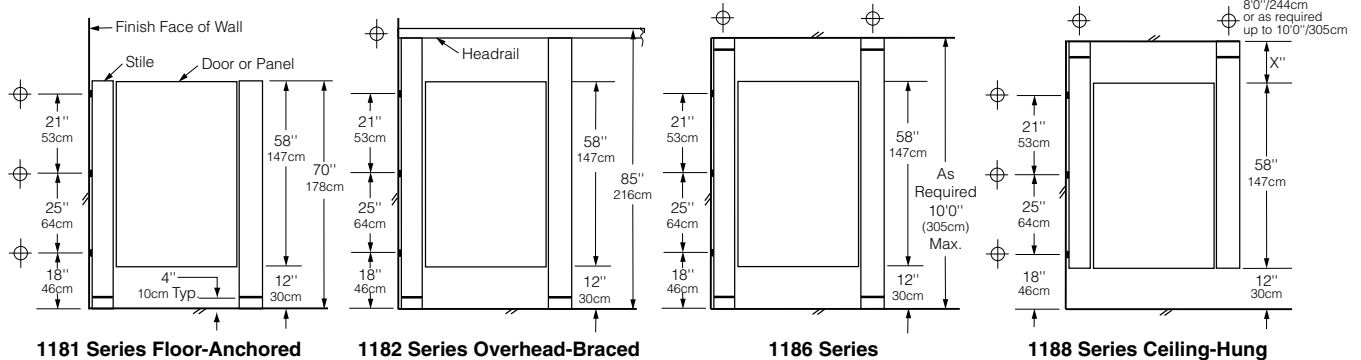

⊕ These mounting points require backing. For suggested backing methods, Bobrick Advisory Bulletins TB-32 for ceiling-hung installations and TB-46 for floor-anchored are available upon request.

TYPICAL HARDWARE DETAILS

Commercial Hardware (standard on all compartments)

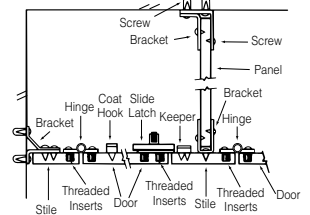

Institutional Hardware (.67 Option)

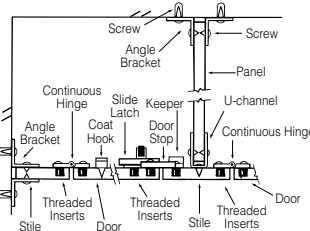

Standard gaps are provided at all walls and between components to allow for hardware attachment.

Wall gaps are standard 1/2" to 1"

TYPICAL INSTALLATION DETAILS

Ceiling Leveling Device

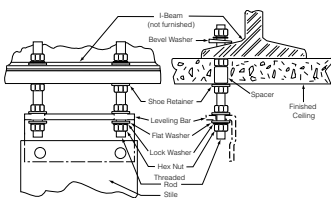

Front

Side

Floor Leveling Device

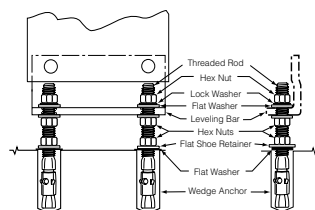

Front

Side

Overhead-Bracing

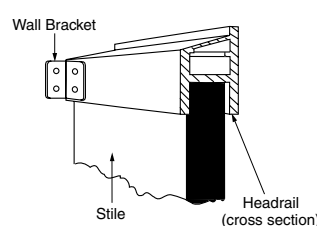

MATERIALS:

Stiles* — 3/4" (19mm) thick, solidly fused plastic laminate with matte-finish melamine surfaces, colored face sheets, and black phenolic-resin core that are integrally bonded. Edges are black. **Leveling Device:** 3/16" (5mm) thick, corrosion-resistant, chromate-treated, double zinc-plated steel angel leveling bar bolted to stile; furnished with 3/8" (10mm) diameter threaded rods, hex nuts, lock washers, flat washers, spacer sleeves, expansion anchors, and shoe retainers. **Shoe:** 18-8 S, type-304, 22-gauge (0.8mm) stainless steel with satin finish; 4" (102mm) high.

**Stiles for 1186 Series floor-to-ceiling anchored have a leveling device at each end.*

Panels — 1/2" (13mm) thick, solidly fused plastic laminate with matte-finish melamine surfaces, colored face sheets, and black phenolic-resin core that are integrally bonded. Edges are black.

Doors — 3/4" (19mm) thick, solidly fused plastic laminate with matte-finish melamine surfaces, colored face sheets, and black phenolic-resin core that are integrally bonded. Edges are black.

Posts (for 1183 Series screens only) — 1-1/4" (32mm) square tubing; 18-8 S, type-304, 18-gauge (1.2mm) stainless steel with satin finish. Floor and ceiling connections are constructed of 18-8 S, type-304, heavy-gauge stainless steel. Furnished in 10-ft (305-cm) lengths; to be cut in field to job specifications.

Headrail (for 1182 Series compartments only) — Extruded anodized aluminum with satin finish. Enclosed construction with sloping top. Face has raised grip-resistant edge.

Designer's Notes: Headrails with integral curtain tracks and hooks are available for compartments without doors. Optional vinyl curtains are available. Benches are available as an optional accessory for dressing compartments and shower dividers: 1/2" (13mm) thick, solidly fused plastic laminate with matte-finish melamine surfaces, colored face sheets, and black phenolic-resin core that are integrally bonded, 10" (25cm) deep, 18" or 24" (46 or 61cm) wide; furnished with two stainless steel support brackets for mounting to wall or divider panel.

Wall Posts (for alternate ADA stall) — 1" x 1-1/2" (25 x 38mm) tubing; 18-8 S, type-304, 16-gauge (1.6mm) stainless steel with satin-finish. 58" (147cm) high, pre-drilled for door hardware.

Commercial Hardware (standard) — Hinges, door latches, door keepers, coat hooks, and mounting brackets are constructed of 18-8 S, type-304, heavy-gauge stainless steel with satin finish. Threaded inserts are factory installed for securing hinges and door latch. Theft-resistant, stainless steel pin-head, torx screws are furnished for door hardware and all mounting brackets. Black rubber bumper on the latch serves as door bumper for inswing door. Balanced hinge is adjustable to hold door of unoccupied toilet compartment partially open or fully closed. Toilet compartment door is locked from inside by sliding door latch into keeper. A locked compartment may be opened from outside by lifting door to disengage latch from keeper. Track of door latch prevents inswing door from swinging out beyond stile; on outswing door, the door keeper prevents it from swinging in beyond stile.

Institutional Hardware (.67 option) — Hinges, door latches, door keepers, U-channels, door stop plates and angle brackets are constructed of 18-8 S, type-304, heavy-gauge stainless steel with satin finish: one-piece, full-height hinge is 16 gauge (1.6mm); one-piece door keeper is 11 gauge (3.2mm); one-piece, full-height U-channels and angle brackets are 18 gauge (1.2mm). U-channels secure panels to stiles, and angle brackets secure panels and stiles to walls. Door latch slides on a shock-resistant nylon track. A locked compartment may be opened from outside by lifting door to disengage latch from keeper. Two doorstops prevent door from being kicked out by vandals. Theft-resistant, stainless steel pin-head, torx screws are furnished for door hardware, U-channels, and angle brackets. Doors are equipped with a self-closing hinge. Threaded inserts are factory installed to secure door hinge, latch, and doorstops. *To specify institutional hardware, add suffix .67 to series number. Example: specify 1182.67 for overhead-braced partitions furnished with institutional hardware, including factory-installed threaded inserts for door hardware attachment.*

INSTALLATION:

Bobrick installation instructions are packed with each shipment and are available also in advance on request.

Notes:

1. Ceiling-hung and floor-to-ceiling toilet compartments require structural members (not furnished by Bobrick) in ceiling. For suggested types of ceiling support systems, see Bobrick Advisory Bulletin TB-32.
2. Wall backing is required to secure the mounting brackets of panels, stiles, and wall posts. For suggested wall backing, see Bobrick Advisory Bulletin TB-46.
3. Floor-anchored stiles are furnished with expansion shields and threaded rods. The expansion shields require minimum 2" (50mm) penetration into minimum 3" (75mm) thick structural concrete.
4. Bobrick stainless steel partition-mounted washroom accessories are available for mounting in panels between two compartments. See current Bobrick Catalog for description of accessories. Cutouts in panels can be pre-cut for Bobrick models at factory if location and size of all cutouts and Bobrick model numbers are furnished at time of order.

GUARANTEE:

Bobrick toilet partitions including all hardware and mounting brackets are guaranteed to be free from defects in material and workmanship for a period of one year from date of purchase. Any products returned to Bobrick under this guarantee will be repaired or replaced at no charge. **15-Year Warranty:** Bobrick extends a fifteen-year limited warranty from date of purchase for DuraLineSeries™ solid phenolic partition panels, doors, and stiles against breakage, corrosion, delamination, and defects in factory workmanship when materials are properly installed, then used and serviced normally.

SPECIFICATION:

Class A fire-resistant, solid phenolic _____ (insert one: toilet partitions, dressing compartments, urinal screens, entrance screens) shall be _____ (insert one: floor-anchored, overhead-braced, floor-to-ceiling anchored, ceiling-hung, wall-hung, post-to-ceiling). Stiles, panels and doors shall be constructed of solidly fused plastic laminate with matte-finish melamine surfaces, colored face sheets, and black phenolic-resin core that are integrally bonded; and covered by a 15-year limited warranty against breakage, corrosion, and delamination. Stiles and doors shall be 3/4" (19mm) thick; panels shall be 1/2" (13mm) thick. All units shall meet NFPA or ICC Class A, UBC Class I, ASTM E-84 Fire-Resistance Standards: flame spread 15, smoke development 25. Stiles shall have leveling device that is concealed by a one-piece, type-304, satin-finish stainless steel shoe that is 4" (102mm) high. Stiles, panels and doors shall be _____ (insert color name and number from current Bobrick Catalog). Headrails for overhead-braced compartments shall be anodized aluminum with satin finish. **All door hardware and mounting brackets shall be type-304 stainless steel with satin finish. No door hardware or mounting brackets shall be exposed on exterior of compartments, except on outswing doors. All doors shall be supplied with three hinges. Threaded inserts shall be factory installed for securing hinges and door latches. Theft-resistant, stainless steel pin-head, torx screws shall be furnished for door hardware and all mounting brackets. A coat hook shall be furnished for each door. Hinges shall be adjustable to hold doors of unoccupied compartments partially open or fully closed, and shall allow a locked compartment to be opened from outside by lifting door to disengage latch from keeper.

***To specify Institutional hardware, replace end of specification paragraph with: .67 option All door hardware, U-channels, and angle brackets shall be type-304 stainless steel with satin finish: one-piece, full-height hinges shall be 16 gauge (1.6mm); one-piece door keepers shall be 11 gauge (3.2mm); one-piece, full-height U-channels and angle brackets shall be 18 gauge (1.2mm). U-channels shall be furnished to secure panels to stiles, and angle brackets furnished to secure panels and stiles to walls. Two doorstops shall be furnished for each door to prevent it from being kicked out by vandals. Theft-resistant, stainless steel pin-head, torx screws shall be furnished for door hardware, U-channels, and angle brackets. Hinges shall allow locked compartment to be opened in emergency from outside by lifting door to disengage latch from keeper. Doors shall be equipped with a self-closing hinge. Threaded inserts shall be factory installed to secure all door hinges, latches, and doorstops. Manufacturer's service and parts manual shall be provided to the building owner/manager upon request.*

_____ (insert one: Toilet Partitions, Dressing Compartments, Shower Dividers, Urinal Screens, Entrance Screens) shall be _____ Series (insert series number) of Bobrick Washroom Equipment, Inc., Clifton Park, New York; Jackson, Tennessee; Los Angeles, California; Bobrick Washroom Equipment Company, Scarborough, Ontario; Bobrick Washroom Equipment Pty. Ltd., Australia; and Bobrick Washroom Equipment Limited, United Kingdom.