

Powder Coated - Headrail Braced ELITE PLUS SERIES Metal Toilet Partitions

Material Specification

1 . 0 1 **Construction**

Doors, Panels and Pilasters shall be constructed of two sheets of panel flatness zinc-coated galvaneal steel, ASTM A653 GR33, laminated under pressure to a honeycomb core for sound deadening and rigidity. Formed edges to be welded together and inter-locked under tension with a roll-formed oval crown locking bar, mitred, welded and ground smooth at the corners. Honeycomb to have a maximum 25mm (1") cell size.

1 . 0 2 **Doors**

Shall be 1816mm (71.5") high and 25mm (1") thick with cover sheets not less than 0.8mm (.030").

1 . 0 3 **Panels**

Shall be 1918mm (75.5") high and 25mm (1") thick with cover sheets not less than 0.8mm (.030").

1 . 0 4 **Pilasters**

Shall be 32mm (1.25") thick with cover sheets not less than 0.9mm (.036").

1 . 0 5 **Headrail**

Shall be 25mm (1") by 41mm (1.625") extruded anodized aluminum with anti-grip design. Wall thickness to be 1.5mm (.060") and shall be securely attached to wall and pilasters with manufacturer's fittings in such a way as to make a strong and rigid installation. All joints in headrails shall be made at a pilaster.

1 . 0 6 **Pilaster Fastening Method**

Pilasters shall be securely and rigidly fastened to the floor and fitted with a jack levelling screw for vertical adjustment. The floor fastening shall be concealed and protected by a 102mm (4") high, die-formed stainless steel pilaster shoe.

1 . 0 7 **Hardware & Fittings**

All panel and pilaster brackets and all door hardware shall be chrome plated zinc die castings. Fasteners are zinc plated 14 x 1-3/4" and 14 x 5/8" TR-27 6-lobe security screws. Doors shall be equipped with gravity type hinges mounted on upper and lower pilaster hinge brackets. Door hinges shall be wrap-around style and adjustable to permit the door to come to rest at any position when not latched. Threaded upper hinge pin shall have a metal core and self lubricating nylon sleeve to ensure smooth, quiet operation. Each door to be fitted with a combined coat hook and bumper and a concealed latch, with face mortised flush with edge strip of door. A full length continuous stop and hinge side filler eliminate all sightline gaps between pilasters and doors.

1 . 0 8 **Finish**

All sheet metal to be thoroughly cleaned, phosphated and finished with a high performance powder coating, baked on to provide a uniform smooth protective finish. Color shall be as selected from Hadrian's color card.

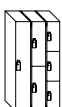
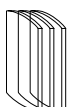

Powder Coated - Headrail Braced ELITE PLUS SERIES Metal Toilet Partitions

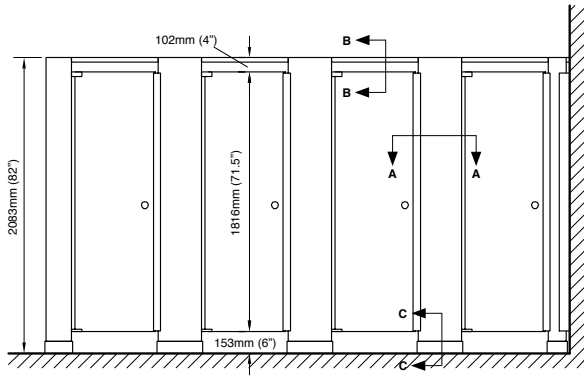

front elevation

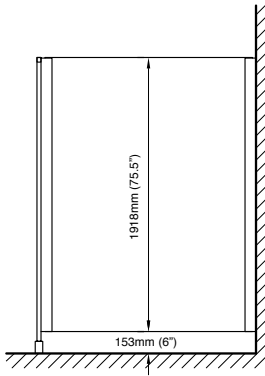

side elevation

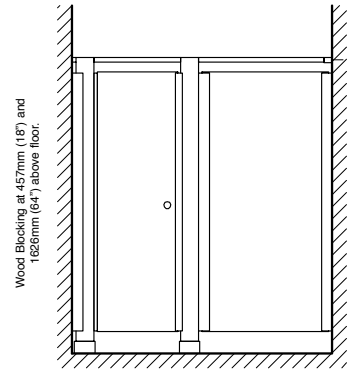

alcove elevation

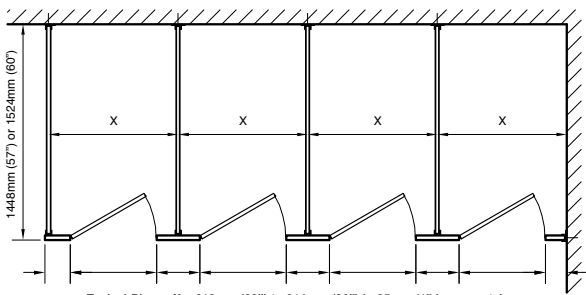

plan

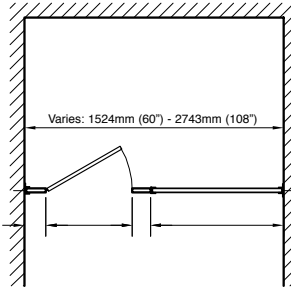

alcove plan

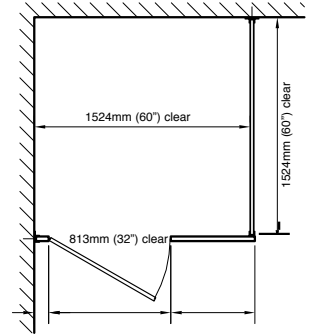

barrier-free plan

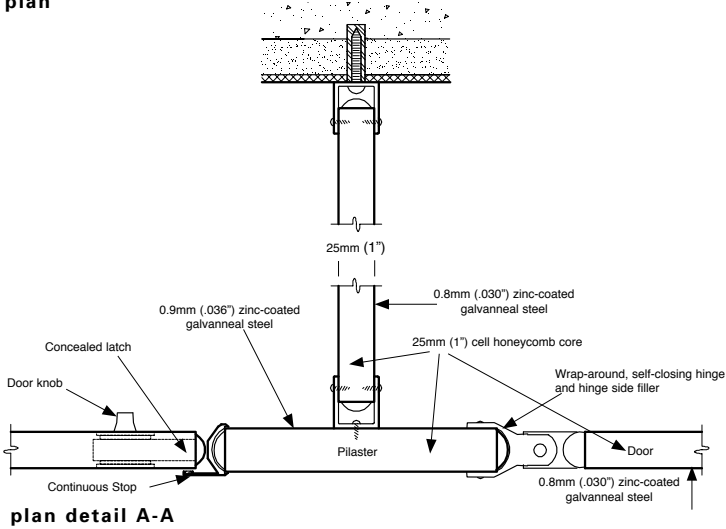

plan detail A-A

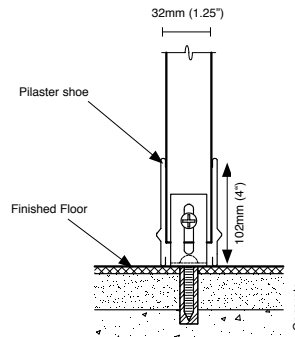

section detail C-C

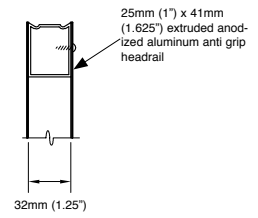

section B-B

Important Note:

Refer to final drawings for wood blocking information. Wood blocking is critical to ensure a rigid installation.

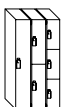
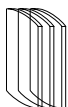

Hadrian Manufacturing Inc., 965 Syscon Road, Burlington, ON, Canada, L7L 5S3

Hadrian Inc.,

7420 Clover Avenue, Mentor, OH, U.S.A., 44060

www.hadrian-inc.com

• Tel: (905) 333-0300

• Tel: (440) 942-9118

• Fax: (905) 333-1841

• Fax: (440) 942-9618